



**Ibstock
Kevington**



THE DEVELOPER CHIMNEY RANGE



Ibstock
At the heart of building



WHAT IS THE DEVELOPER RANGE?

As one of the most immediately visible aspects of a property's exterior, chimneys play an important role in shaping the aesthetic feel of a home.

For large-scale housing developers, who can be building hundreds of homes across one plot, specifying the right chimney can be acutely challenging. Alongside the obvious aesthetic element, developers must also consider practicalities such as unit cost and ease-of-install.

Ibstock's Developer Chimney range has been specifically designed to provide housing developers nationwide with an attractive, cost-effective and easy-to-install solution.

Building on the popularity of our Faststack chimney family, our Developer range has been especially configured to meet the needs of housebuilders. Available in a range of set sizes and with a multitude of eye-catching finishes, chimneys in the Developer range come with a rain bar plate as standard – making installation easier, and more time efficient, than ever before.

BRICK EFFECT OR FACTORY FINISH RENDER TEXTURE BENEFITS

- ✓ Lightweight
- ✓ No Pointing Required
- ✓ Can Match most Bricks and BS or RAL Colour Codes
- ✓ Innovative Fixing Plate
- ✓ Stainless Steel Fixings
- ✓ Marine Grade 4mm thick GRP one piece water tested core and Fixing Plate

BRICK OR STONE CLAD CHIMNEYS BENEFITS

- ✓ Most Manufacturers Bricks and Reconstructed Stone are suitable for Cladding
- ✓ Certified Lifting Loops
- ✓ Innovative Fixing Plate
- ✓ Stainless Steel Lifting Sockets
- ✓ Stainless Steel Fixings
- ✓ Marine Grade 4mm thick GRP one piece water tested core, and Fixing Plate

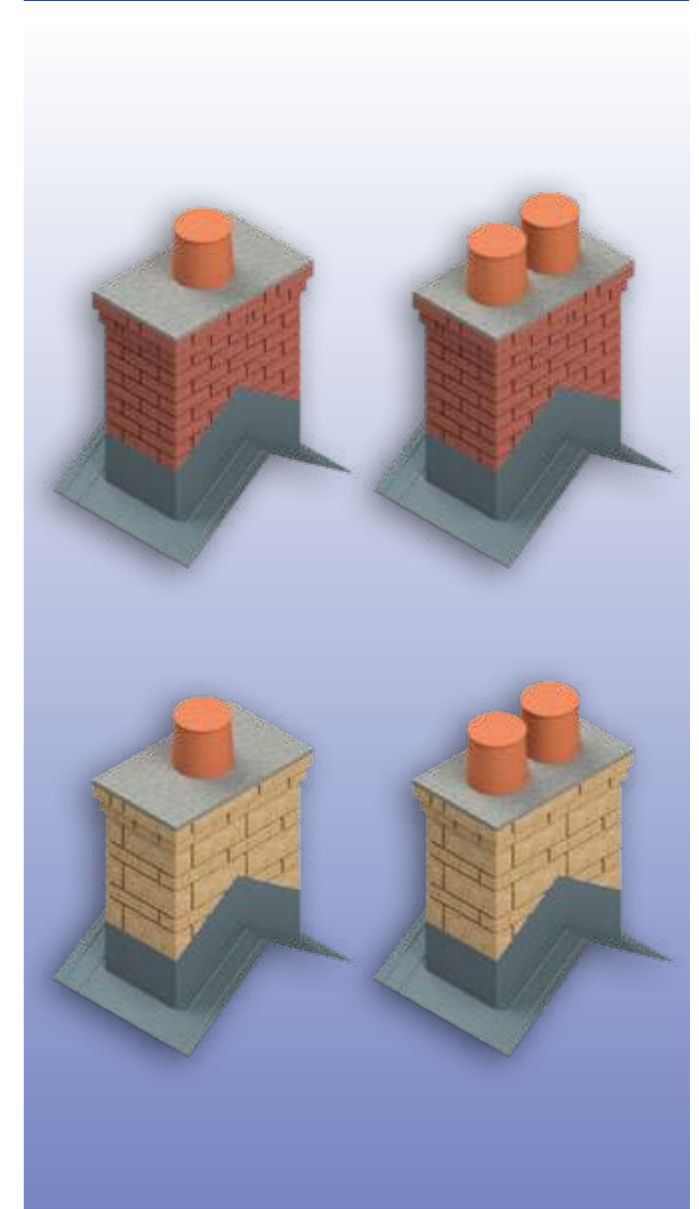
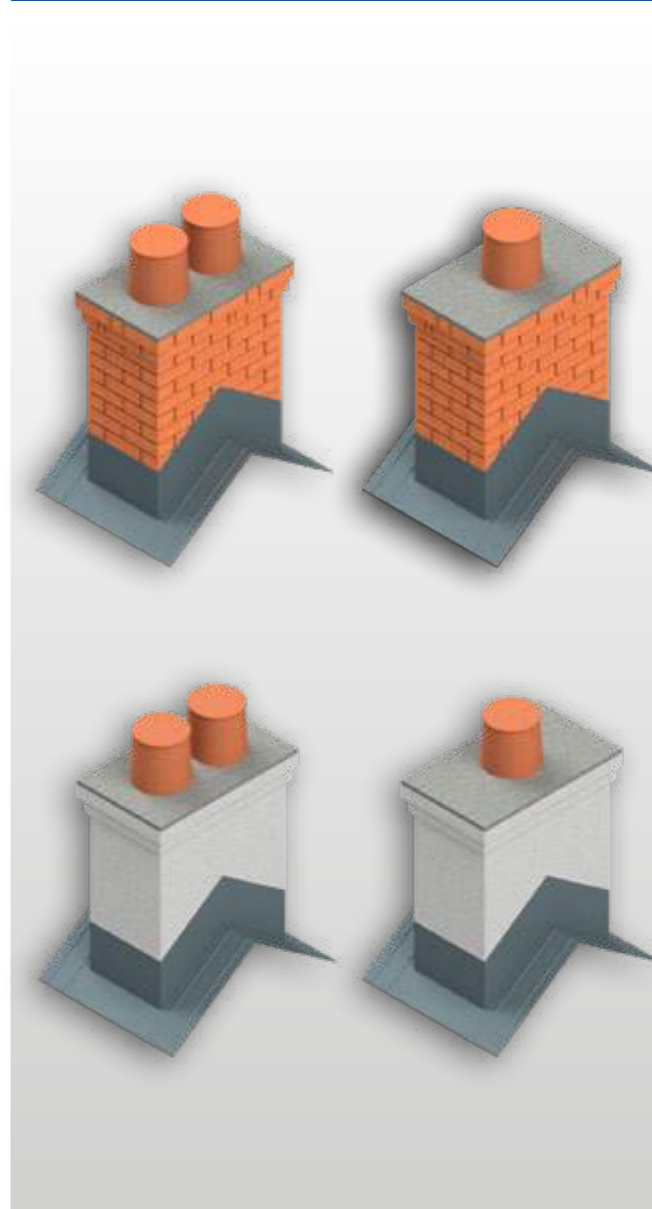

DEVELOPER RANGE

CHIMNEY FIXING STATEMENT

Flashing detail

The standard flashing design incorporates the illustrated rain bar system. This design does not have a flashing channel and is far easier to install than traditional chimney flashing.

A lead apron is installed front and rear and the area below where the channel would have been is already lead colour for authenticity. Please see the below installation guide and familiarise yourselves with the process. This is a great system which is similar to the one used with Dormer windows. It is simple and far more straightforward than the flashing channel approach. All chimneys can be supplied complete with the necessary lead aprons attached to the base plate front and rear at an extra cost. This simplifies the process further and is offered as an extra-over.



Chimneys are compact and easy to install, saving both room space and time on-site.



Certified lifting system ensures safety.



All of our chimneys can be made using any brick, stone or render from your project for the best match.



Real brick slips weather naturally to match existing facings.



One piece corners for seamless appearance.



4mm one piece GRP water tested core – available in Class O.



Tested for long term durability.



Innovative, leak proof, flashing channel.



Single or Double GRP pots.



Integrated fixing plate allows total flexibility.

TECHNICAL INFORMATION

Range

- Consists of both slip clad & fully GRP chimneys
- Competitive range in a set size

Finishes

- Brick or Coursing stone clad & brick effect / mock render finish
- Render as well as GRP Mock Render
- Cap - flat top for site flaunching

Roof Locations

- Mid ridge only

Sizes

- Bespoke sizes not available. Standard height 740mm, no bespoke heights available
- One size - 777 x 440mm

Limitations

- Set heights & corbel detail
- No bespoke available
- Standard sizes/designs only

Venting

- Non-venting only

Accreditation & Literature

- BBA & CGMA certified products
- All ranges supported with literature including; brochures, installation guides & CAD drawings

Construction methods

- GRP marine grade core clad with real slips OR fully GRP with mock slips/render

SEE PAGE 6 FOR A DETAILED CHIMNEY INSTALLATION GUIDE



1. ✓

Party wall blanking plates

Party wall fire blanking plates can be included to ensure chimneys adhere to fire regulation.

2. ✓

Installation

The Developer Chimney range allows for quick and easy installation. A typical installation guide is shown on Page 6. A hard copy of the installation guide is included with all deliveries.

3. ✓

Brick effect chimneys only

Brick effect chimneys are supplied with a standard mortar colour only.

4. ✓

Brick and stone clad chimneys

Brick and stone clad chimneys are supplied with 10mm open joints. Site controlled mortar is to be applied on site to match the mortar on each building.

5. ✓

Corbel design

The Developer Chimney range is supplied with a standard corbel detail (shown opposite). The top two courses are stepped out by 20mm per course. If an alternative corbel detail is required this is available with our bespoke Faststack chimney range.

BRICK-EFFECT MID RIDGE CHIMNEY

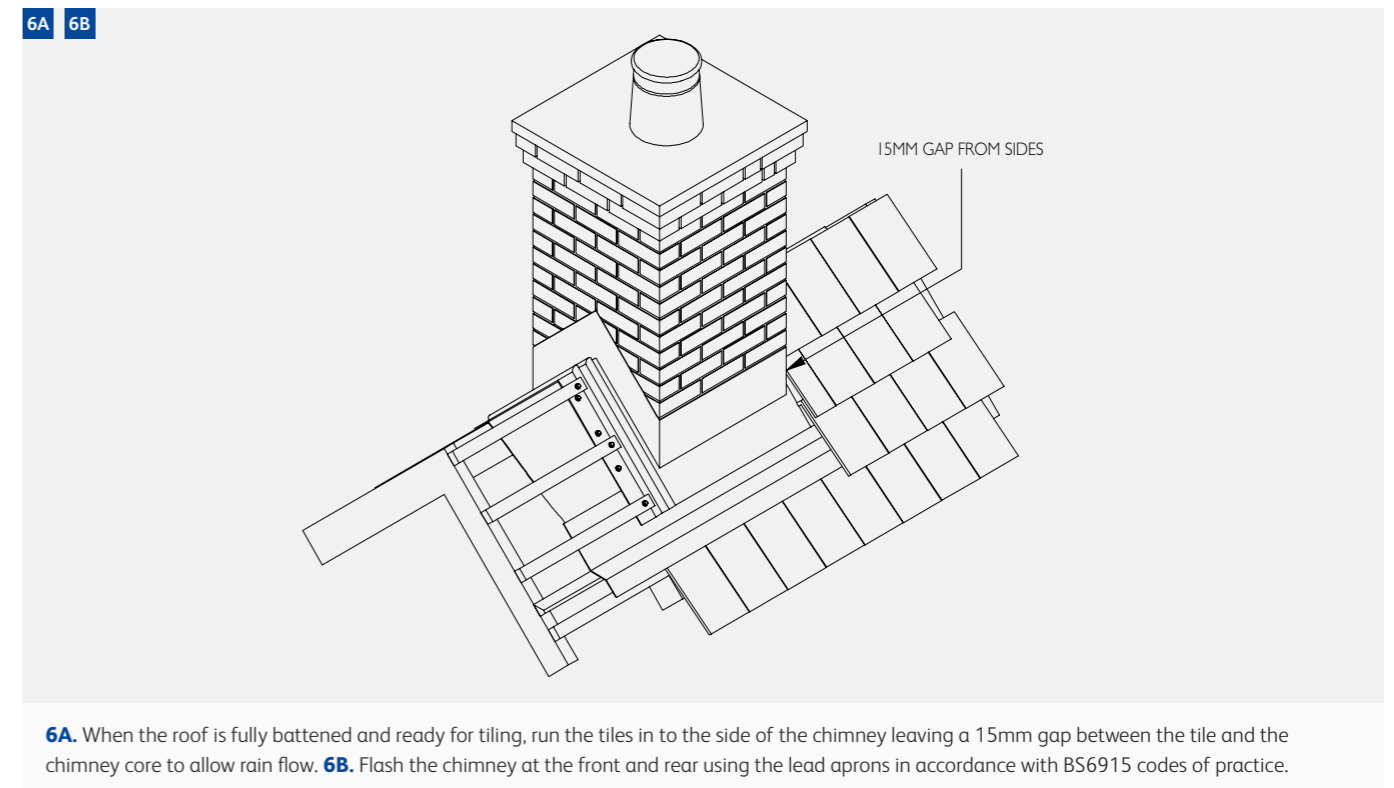
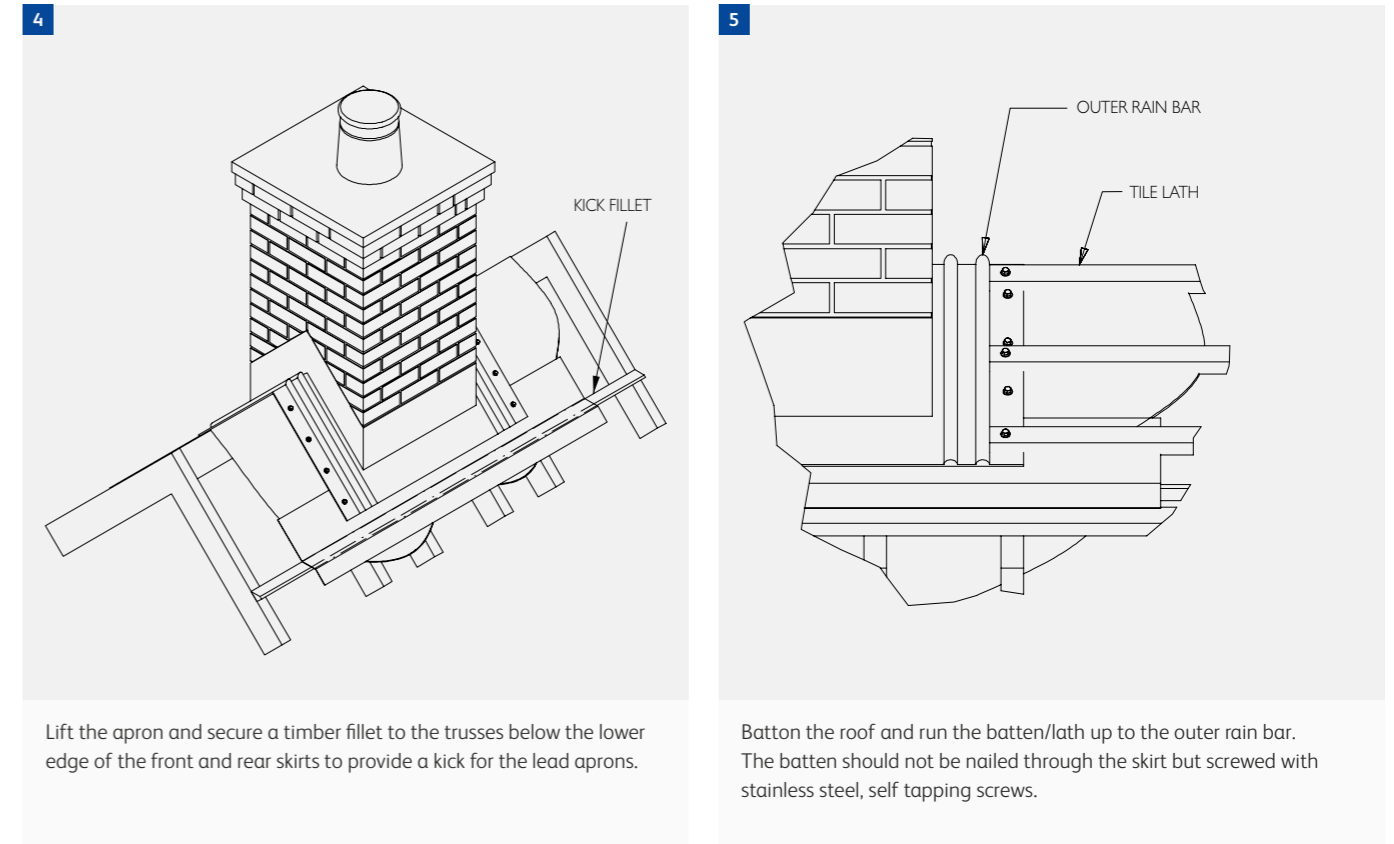
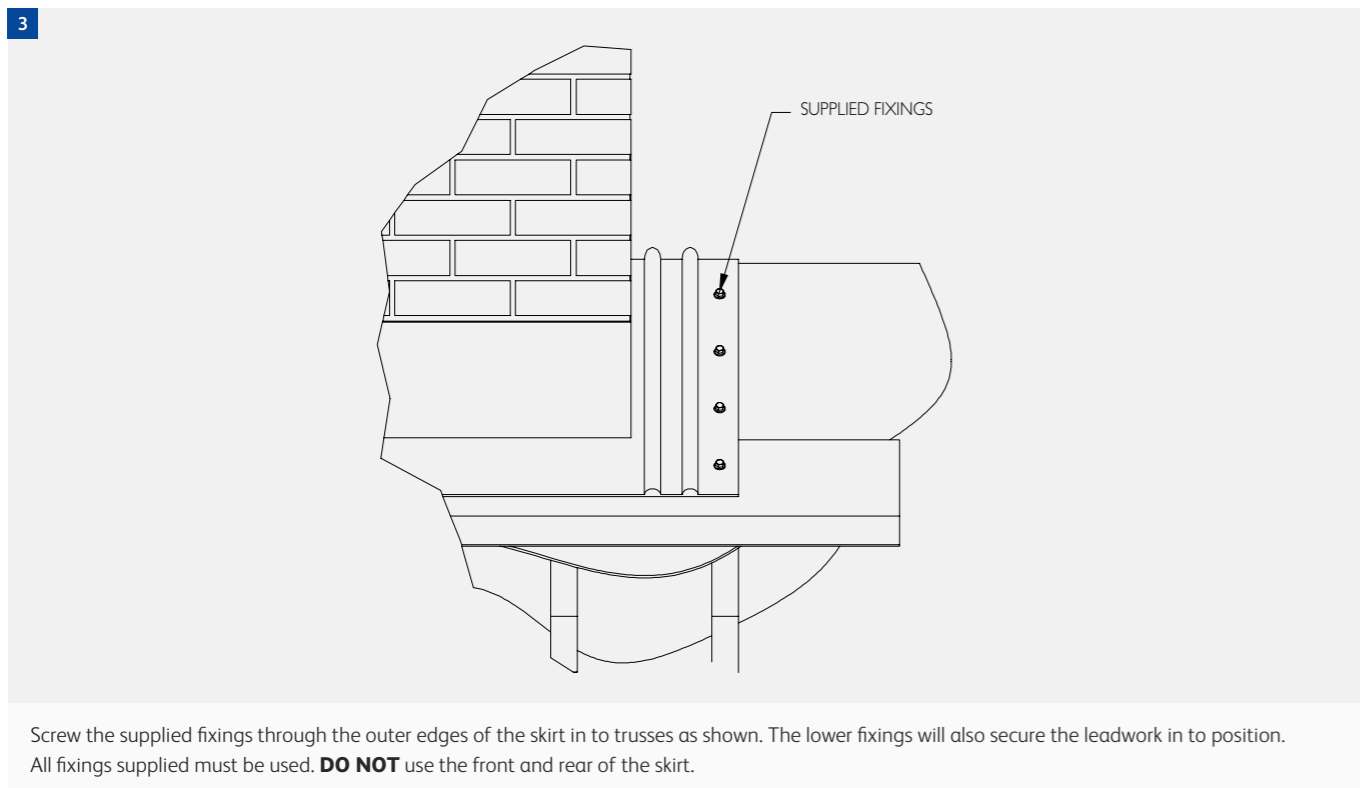
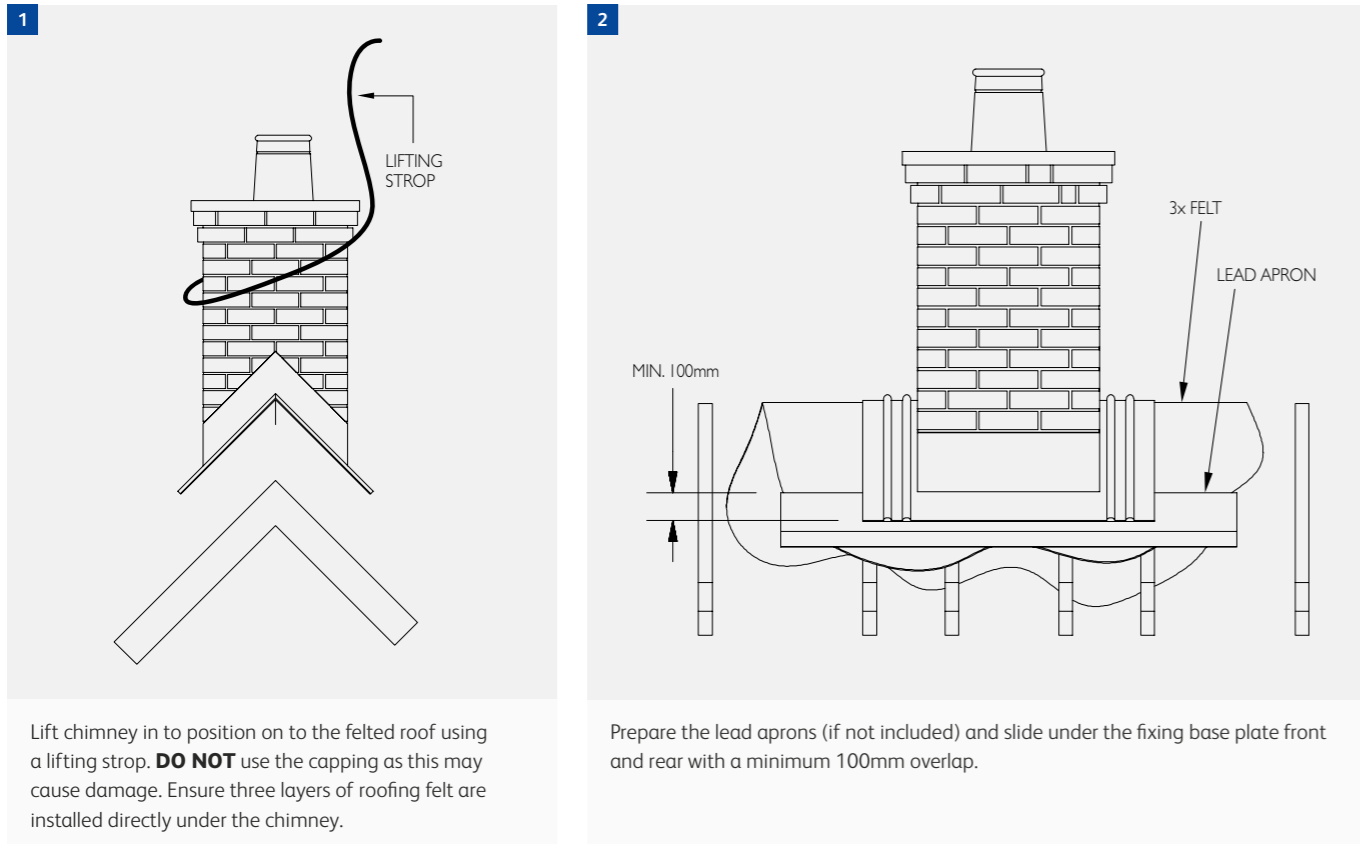

SATELLITE DISHES AND TELEVISION AERIALS MUST NOT BE FIXED TO THE CHIMNEY

SATELLITE DISHES AND TELEVISION AERIALS MUST NOT BE FIXED TO THE CHIMNEY

NOTE: GUARANTEE ON THIS PRODUCT WILL BE INVALIDATED IF INSTRUCTIONS ARE NOT ADHERED TO, THE ONLY APPROVED SEALANTS AND FIXINGS ARE THOSE SUPPLIED BY IBSTOCK KEVINGTON.

NOTE: IF ANY ALTERNATIVES ARE USED THE GUARANTEE WILL BE INVALIDATED.

TECHNICAL DESIGN SERVICE

We will work with you on your Chimney specification including drawings until approval, free of charge.

Here's an example of our Chimney technical drawings:

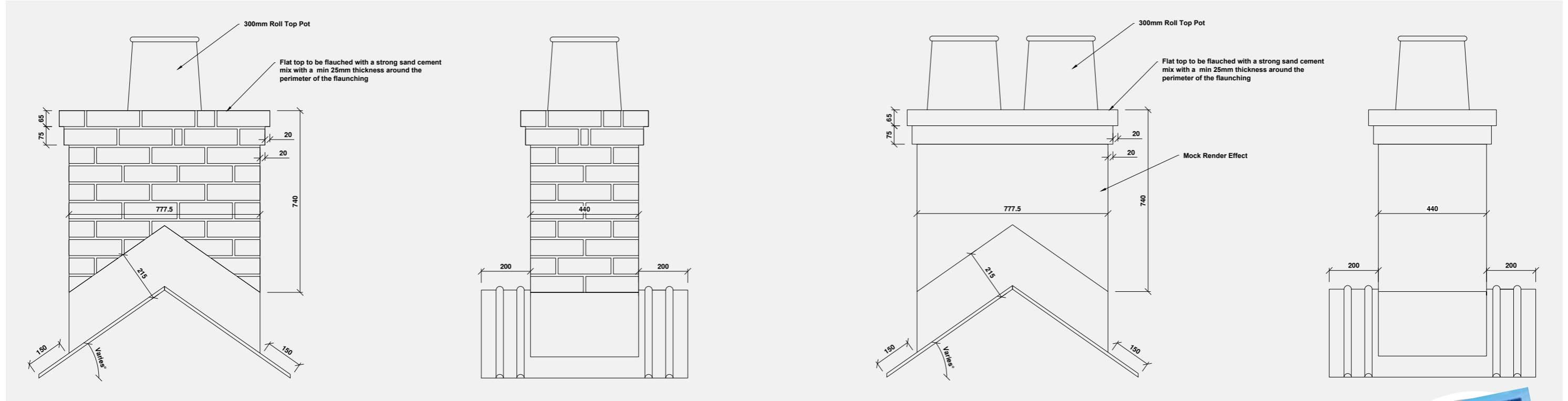

WHAT WE OFFER

1. ✓

Faststack range

- Our main range of chimneys, Faststack:
- come in a variety of sizes and are suitable for many roof locations
- they can include venting
- generally supplied as a GRP core clad in real brick slips but can come in a number of finishes
- bespoke variants are also available

2. ✓

Developer range

- Ibstock's Developer Chimney range has been specifically designed to provide housing developers nationwide with an attractive, cost-effective and easy-to-install solution
- Building on the popularity of our Faststack chimney family, our Developer range has been especially configured to meet the needs of housebuilders

3. ✓

Brick Effect Chimneys

- Lightweight
- Fully GRP chimney with a brick effect finish



25 YEAR WARRANTY



Approved by NHBC



Our GRP Slip, Stone and Render Clad units have BBA certification



Our fully GRP units are CGMA certified

The NHBC recommend that only chimneys that are made to CGMA standards or third party accreditations are to be used. NHBC Technical Advice. June 2012.

HEAD OFFICE

Ibstock Plc, Leicester Road, Ibstock, Leicestershire, LE67 6HS

T: 0844 800 4575

E: enquiries@ibstock.co.uk

www.ibstockbrick.co.uk

